

Smart modulator installation instructions

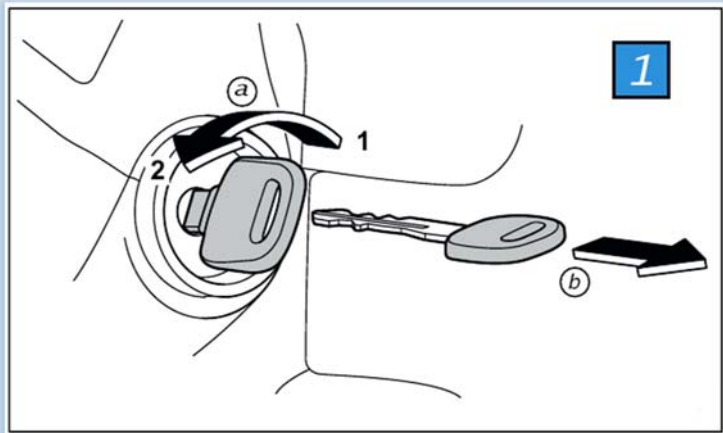

REMOVE KEY FROM IGNITION

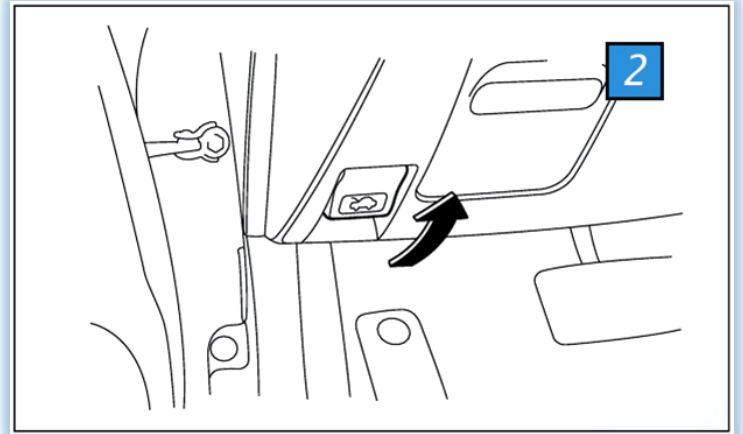

**OPEN THE HOOD FROM THE PASSENGER
COMPARTMENT**

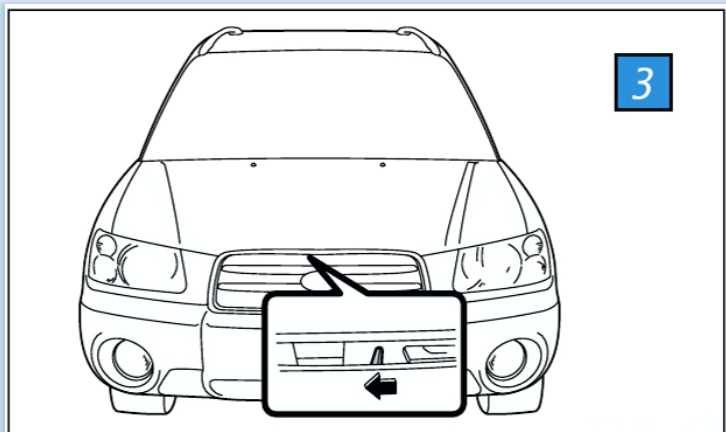

LOCK THE HOOD

OPEN THE HOOD

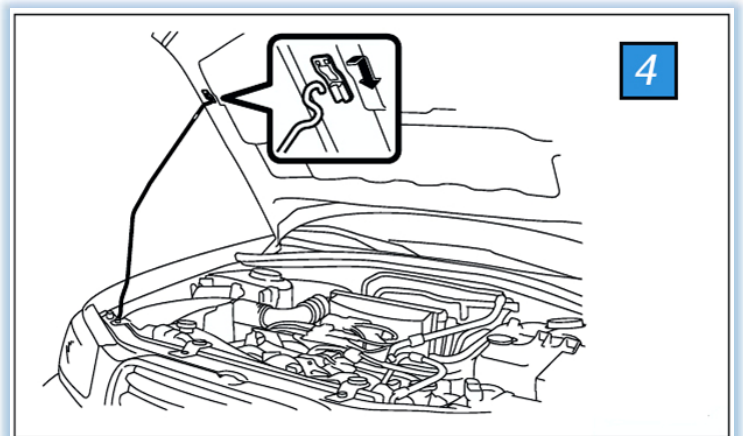

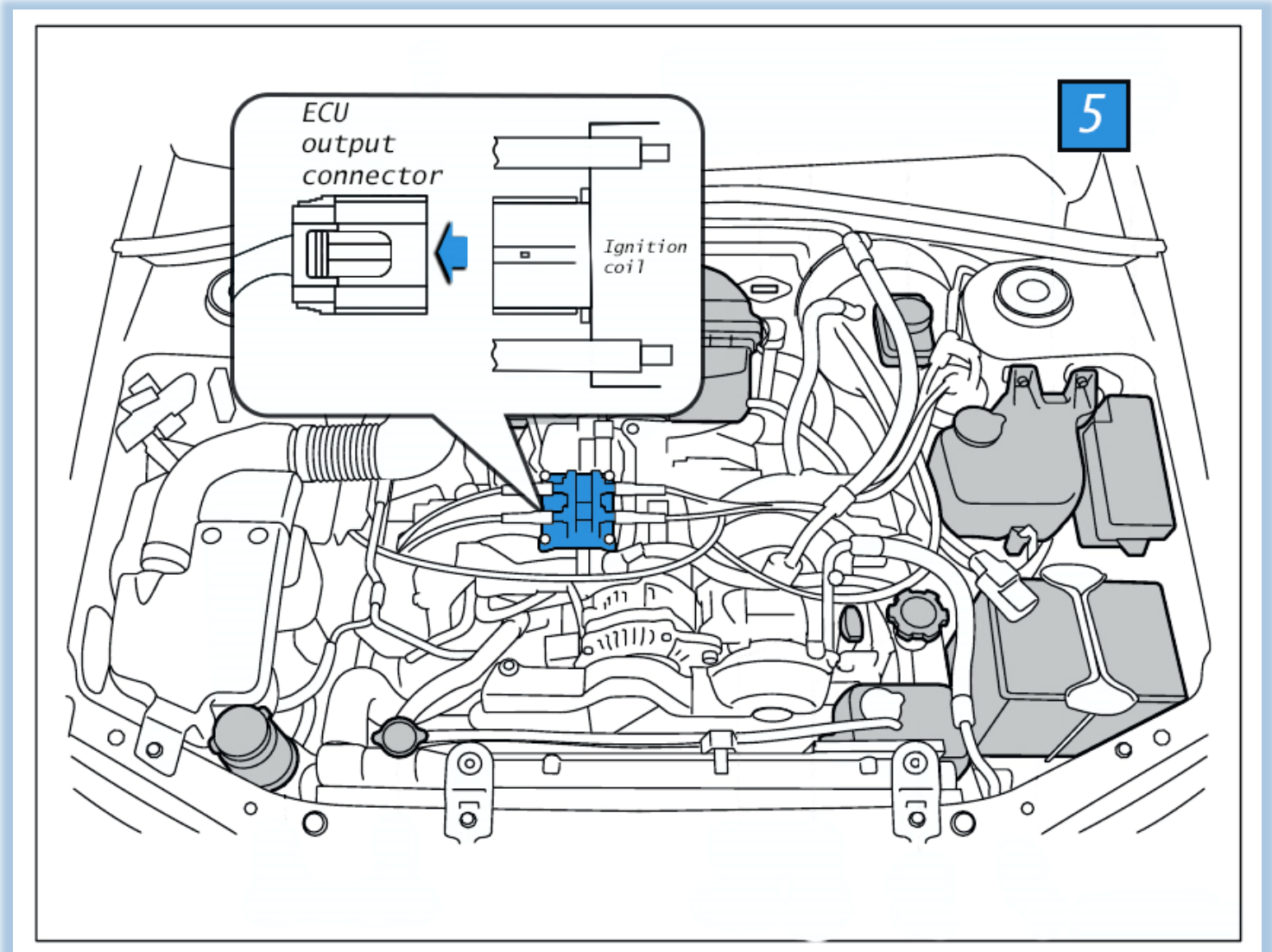

UNPLUG ECU OUTPUT CONNECTOR FROM THE IGNITION COIL

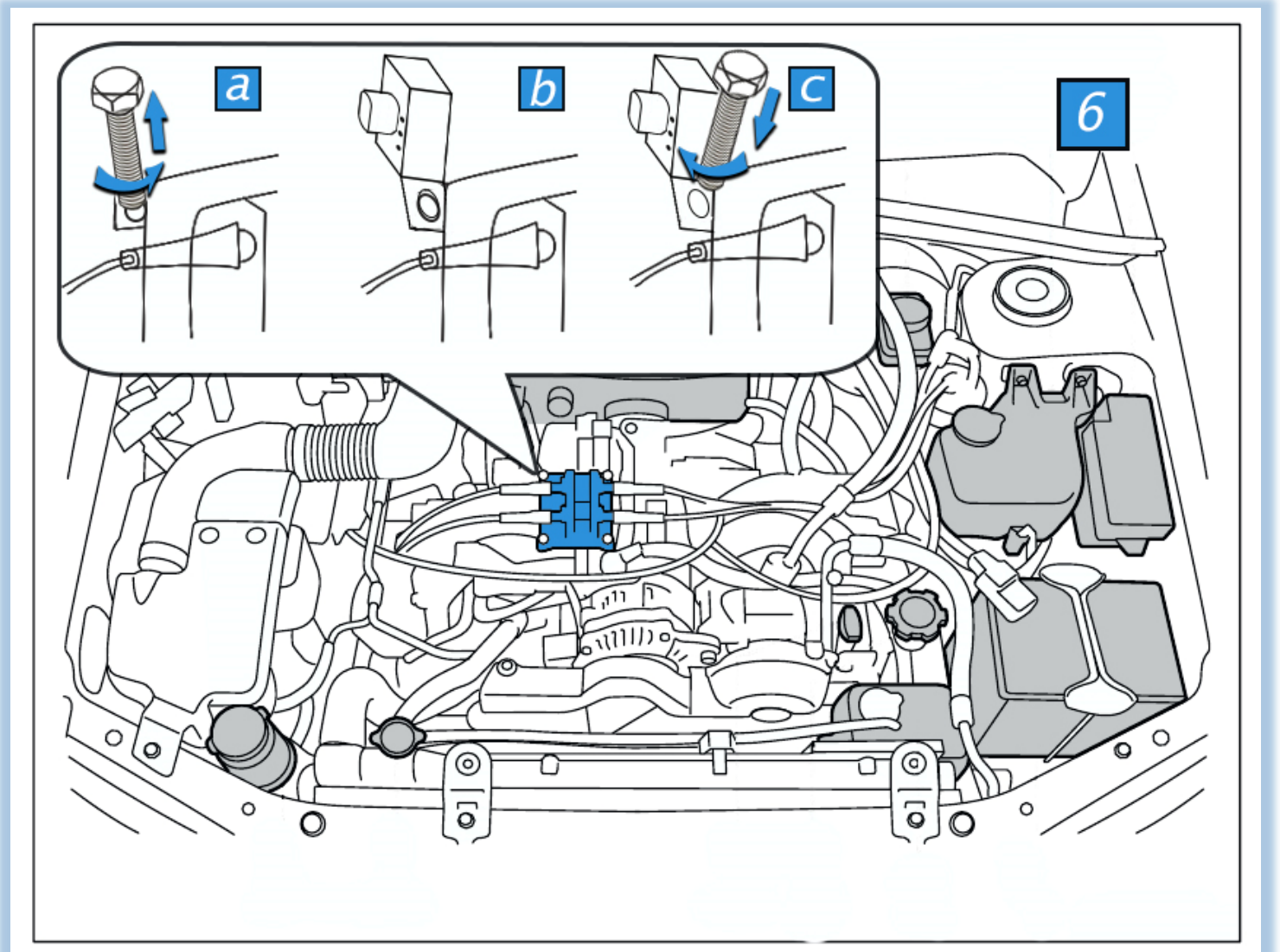

- a) UNSCREW THE UPPER LEFT BOLT NEAR THE IGNITION COIL
- b) FIX THE MODULATOR NEAR THE HOLE
- c) TIGHTEN THE LEFT UPPER BOLT NEAR THE IGNITION COIL

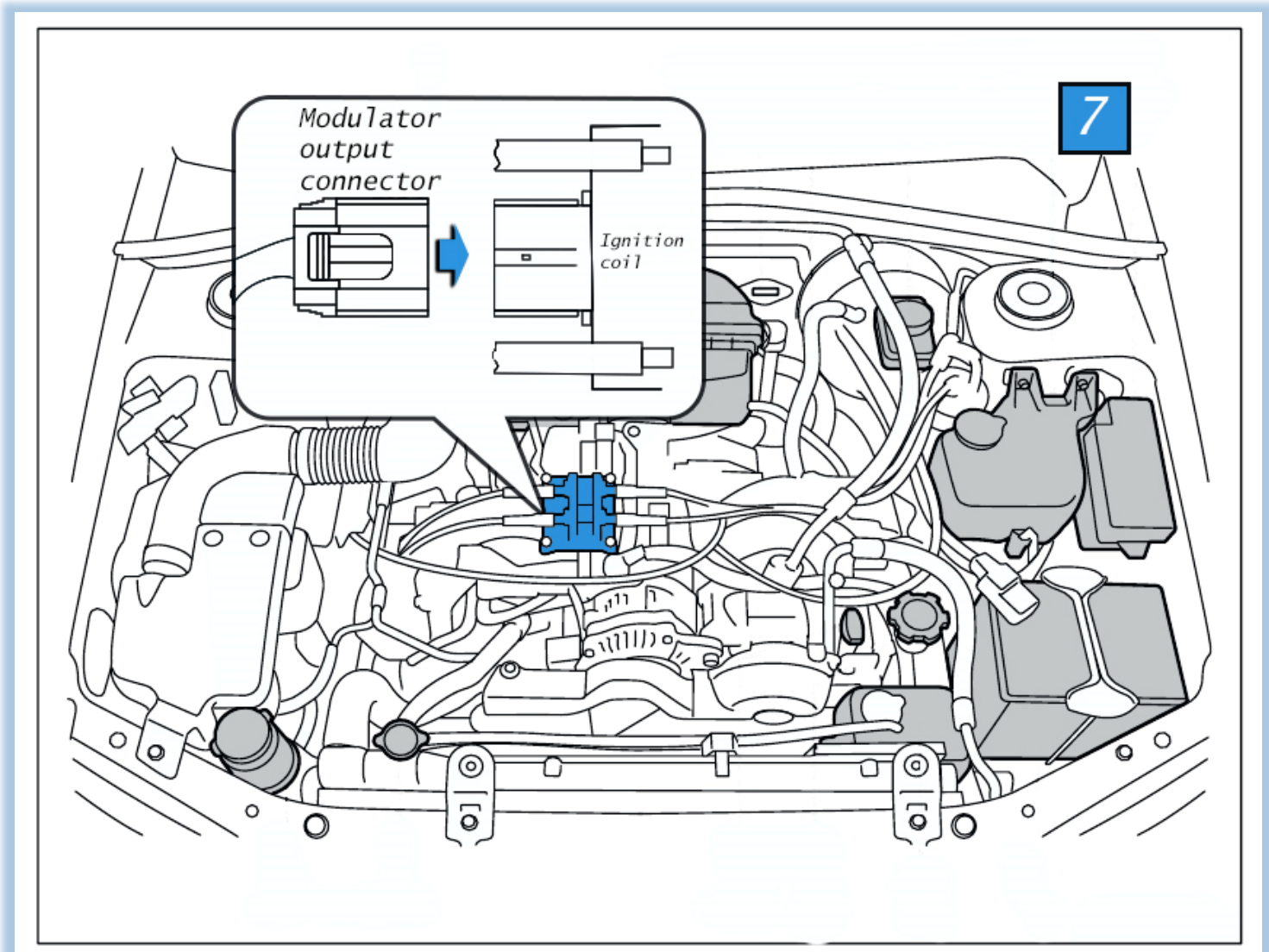

PLUG IN MODULATOR OUTPUT CONNECTOR TO THE IGNITION COIL

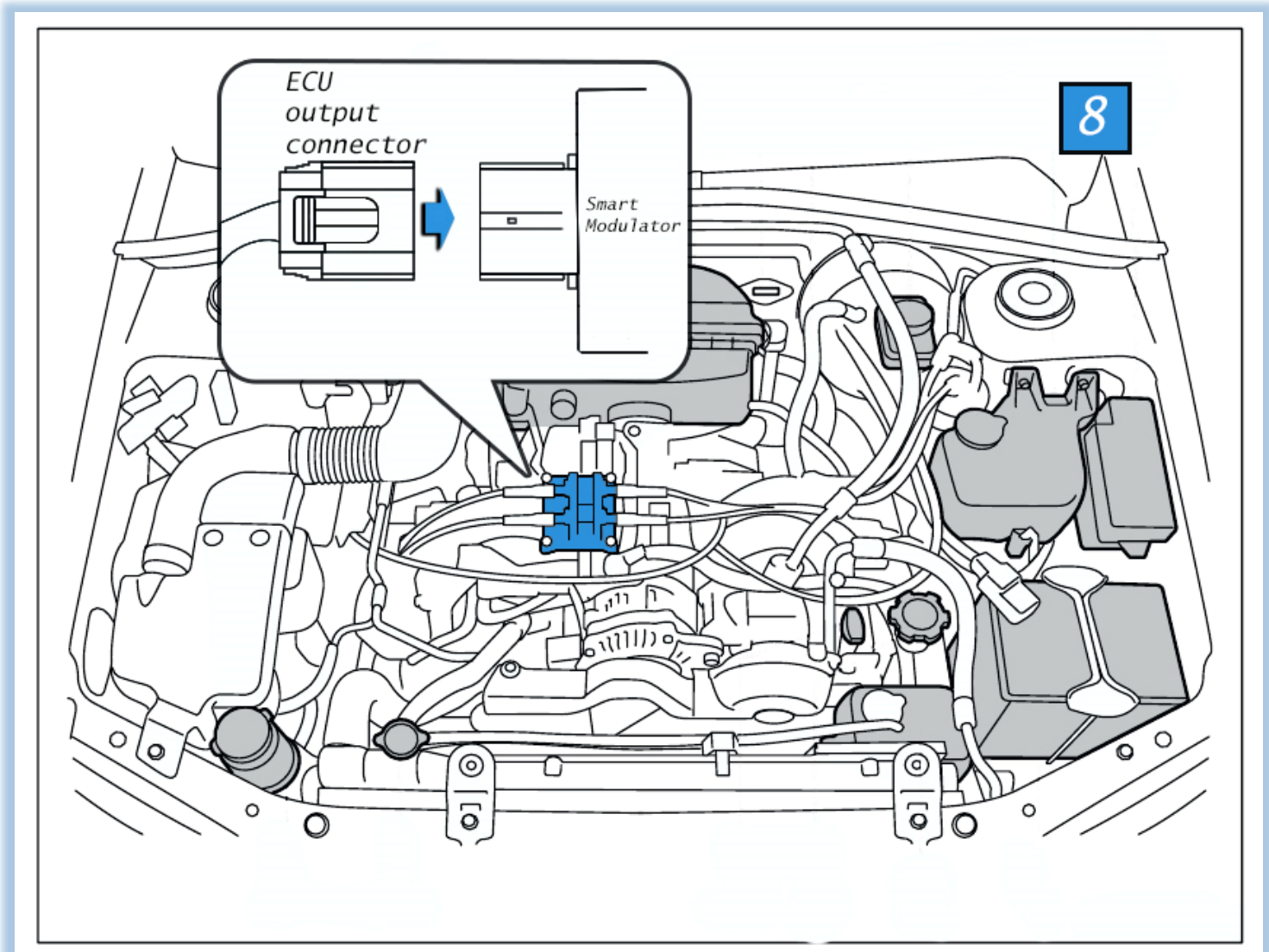

PLUG IN ECU OUTPUT CONNECTOR TO MODULATOR